

Three-terminal positive voltage regulator

FEATURES

- Maximum output current IOM: 0.5A
- Output voltage VO: 12V
- Continuous total dissipation
PD: 1.5W (T a = 25 °C)

MECHANICAL DATA

- Case: TO-220 Small Outline Plastic Package
- Polarity: Color band denotes cathode end
- Mounting Position: Any

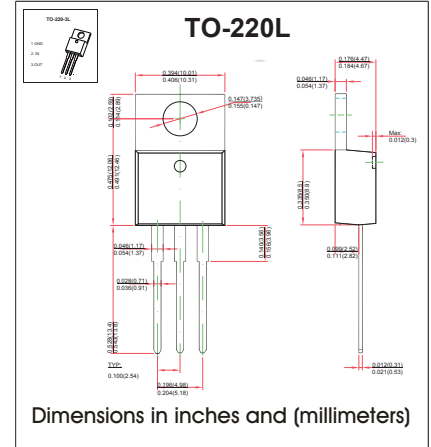

MAXIMUM RATINGS AND CHARACTERISTICS

@ 25°C Ambient Temperature (unless otherwise noted)

Parameter	Symbol	Value	Unit
Input Voltage	V_i	35	V
Thermal Resistance from Junction to Ambient	$R_{\theta JA}$	66.7	°C/W
Operating Junction Temperature Range	T_{OPR}	-25~+125	°C
Storage Temperature Range	T_{STG}	-65~+150	°C

ELECTRICAL CHARACTERISTICS ($V_i=19V, I_o=350mA, C_i=0.33\mu F, C_o=0.1\mu F$, unless otherwise specified)

Parameter	Symbol	Test conditions	Min	Typ	Max	Unit	
Output Voltage	V_o	25°C	11.5	12	12.5	V	
		$14.5 \leq V_i \leq 27V, I_o=5mA-350mA$	-25-125°C	11.4	12	12.6	V
Load Regulation	ΔV_o	$I_o=5mA-500mA$	25°C		25	240	mV
		$I_o=5mA-200mA$	25°C		10	120	mV
Line Regulation	ΔV_o	$14.5V \leq V_i \leq 30V, I_o=200mA$	25°C		10	100	mV
		$16V \leq V_i \leq 30V, I_o=200mA$	25°C		3	50	mV
Quiescent Current	I_q	25°C		4.6	6	mA	
Quiescent Current Change	ΔI_q	$14.5V \leq V_i \leq 30V, I_o=200mA$	-25-125°C			0.8	mA
	ΔI_q	$5mA \leq I_o \leq 350mA$	-25-125°C			0.5	mA
Output Noise Voltage	V_N	$10Hz \leq f \leq 100KHz$	25°C		75	$\mu V/V_o$	
Ripple Rejection	RR	$15 \leq V_i \leq 25V, f=120Hz, I_o=300mA$	-25-125°C	55	80	dB	
Dropout Voltage	V_d	$I_o=350mA$	25°C		2	V	
Short Circuit Current	I_{sc}	$V_i=19V$	25°C		240	mA	
Peak Current	I_{pk}		25°C		0.7	A	

* Pulse test.

TYPICAL APPLICATION

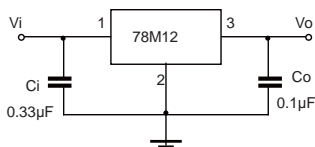

Note: Bypass capacitors are recommended for optimum stability and transient response and should be located as close as possible to the regulators.

TYPICAL APPLICATION

Output Characteristics

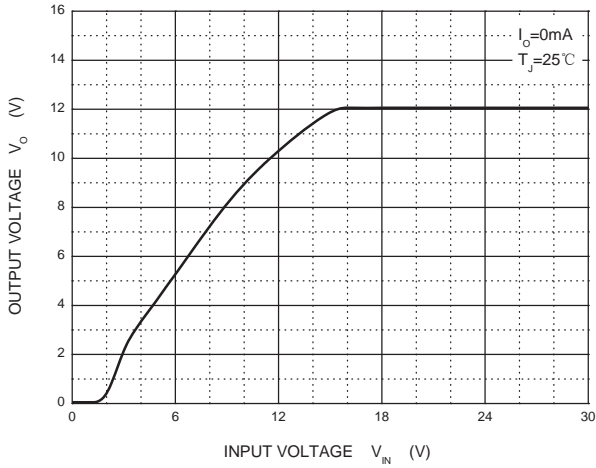

Dropout Characteristics

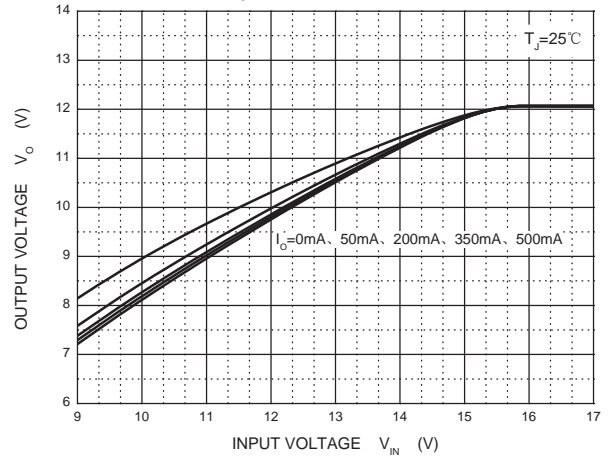

Quiescent Current vs Input Voltage

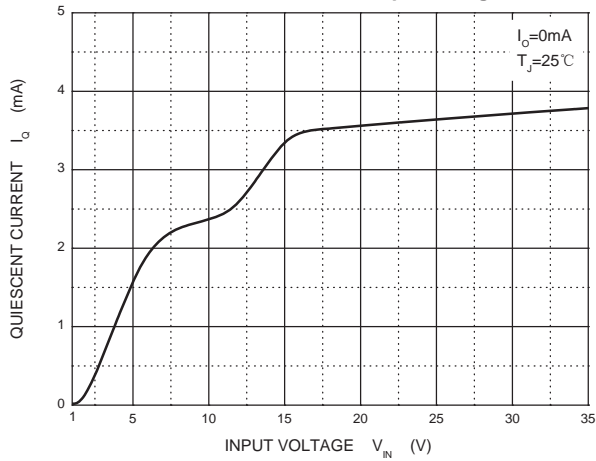

Current Cut-off Grid Voltage

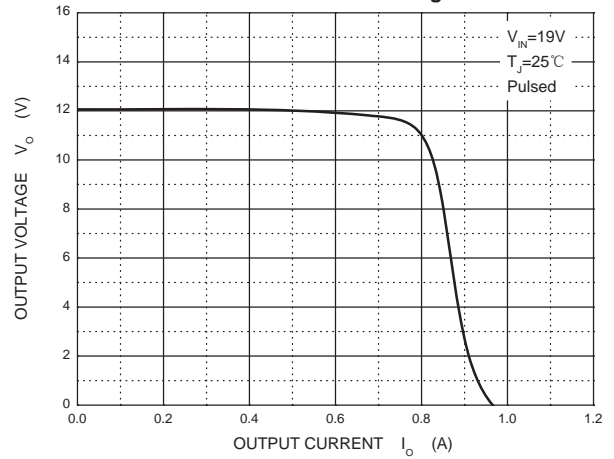

Output Voltage vs Junction Temperature

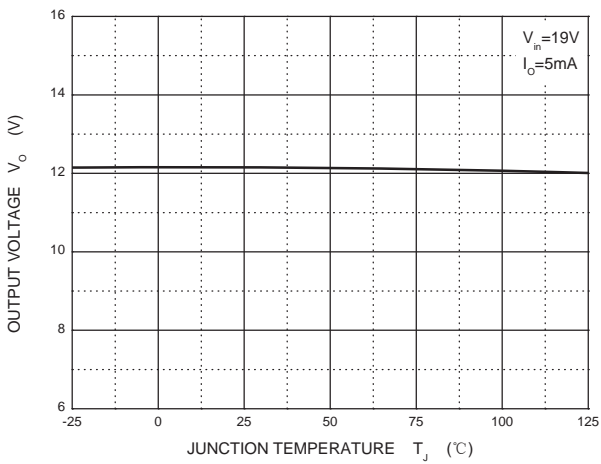

Power Derating Curve

